



Description:

Module.....Dashboard
 Manufacturer.....M.A.E. elettronica
 Ref OEM.....40610951 [D/E/F]
 40610952E
 40610953E
 40611221 [B/C]
 40611222 [B/C]

 Memory device.....Eeprom 24C02
 Memory size.....256 bytes

 Vehicles.....Hypermotard 821 MY 2013-2015
 Hypermotard 821SP MY 2013-2015
 Hyperstrada 821 MY 2013-2015
 Hypermotard 939 MY 2016-2018
 Hypermotard 939SP MY 2016-2018
 Hyperstrada 939 MY 2016-2018

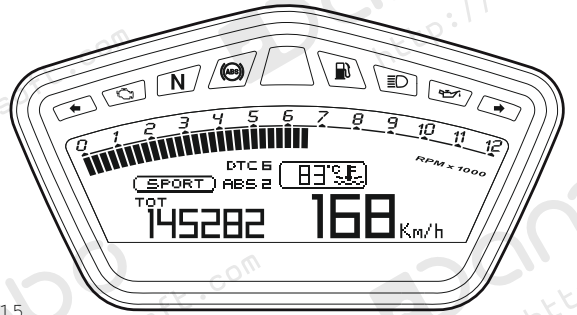

Immobilizer System:

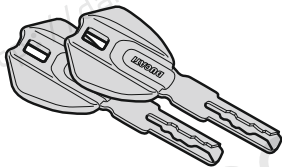

- Ducati I2K-2 Immobilizer system.
- All vehicles equipped with I2K-2 Immobilizer system have a standard supply consisting in 2 keys.
- The Keys are provided with a passive transponder Texas DST-80.
- The key electronic codes are stored in the instrument panel control unit that work as Immobilizer.
- The number of keys that can be memorized by the I2K-2 system is 2 and it is not possible to program one or more than 2 keys.

Software options:

- * Immobilizer Keys programming
- * Show PIN code
- * VIN code edit
- * Odometer correction

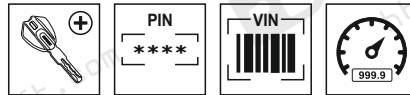

WARNING



The Immobilizer release function via Pin Code is available **ONLY** if the Customer has performed the memorization procedure of the secret code.

Spare tools/units:

- * Key Copy Tool - Copy Texas Crypto DST transponders
- * Key Production - Ducati Scrambler transponder generation



Description:

Module.....Key operated switch
 Manufacturer.....ZADI
 Ref OEM.....38510201B

Memory device.....9S12P128 Freescale MCU
 Memory type.....MCU Eeprom
 Memory size.....4096 bytes

Vehicles.....	Panigale 1199	MY 2012-2014
	Panigale 1199 S	MY 2012-2014
	Panigale 899	MY 2014-2015
	Panigale 959	MY 2016-2018
	Panigale 959 Corse	MY 2019

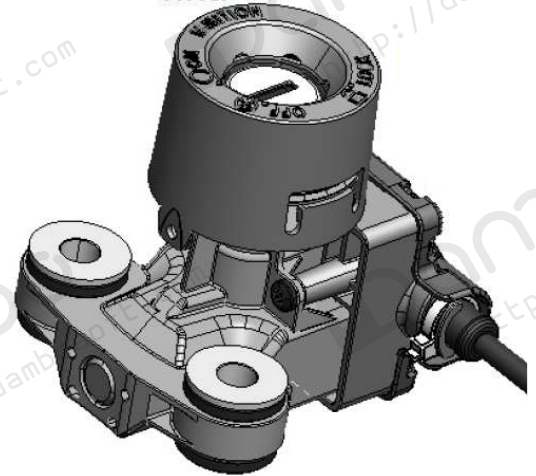

Immobilizer System:



- Ducati E-LOCK Immobilizer system.
All vehicles equipped with E-Lock Immobilizer system have a standard supply consisting in 2 Keys.
- The keys are provided with passive transponder powered by the antenna integrated in the ELock control unit.
- The minimum number of keys that can be memorized by the E-LOCK system is 1.
- The maximum number of keys that can be memorized is 4.

Software options:

- * Immobilizer Keys programming
- * Show PIN code



WARNING



The Immobilizer release function via Pin Code is available **ONLY** if the Customer has performed the memorization procedure of the secret code.

Spare tools/units:

- * Key Copy Tool - Copy Texas Crypto DST transponders
- * Key Production - Ducati transponder generation
- * Dump Tools/Unit Dt0014 - Ducati Panigale Dashboard



Description:

Module.....Dashboard
 Manufacturer.....COBO Group S.p.A.
 Ref OEM.....40610902G
 40610991D/C
 40610992D
 40610936D
 40611243B

 Memory device.....Eeprom 24C512
 Memory size.....65536 bytes

 Vehicles.....Panigale 1199 MY 2012-2014
 Panigale 1199 S MY 2012-2014
 Panigale 899 MY 2014-2015
 Panigale 959 MY 2016-2018
 Panigale 959 Corse MY 2018-2019

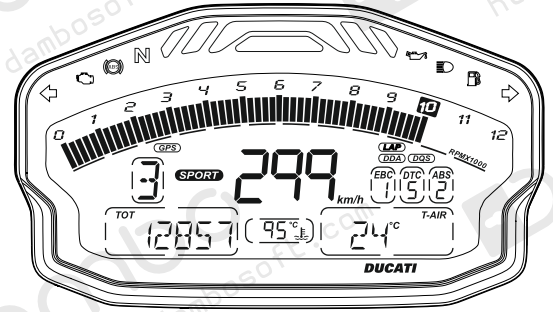
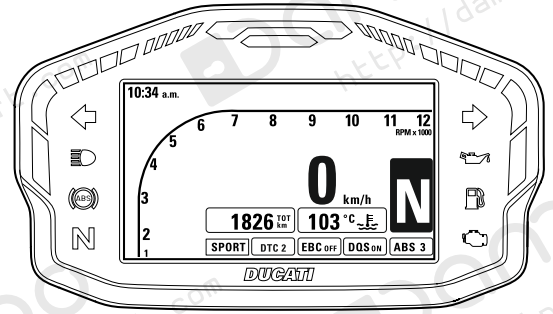

Software options:

* Odometr correction



Spare tools/units:

- * Dump Tools/Unit DT0020 - Ducati Black Box control unit
- * Dump Tools/Unit Dt0012 - ZADI E-lock immobilizer (Key operated switch unit)
- *



Description:

Module.....Dashboard
 Manufacturer.....COBO Group S.p.A.
 Ref OEM.....40611042L
 40611335C
 40611504A
 40611183E
 40611584A

Memory device.....Eeprom 24C0512
 Memory size.....65536 bytes

Vehicles.....Monster 821 MY 2018-2020
 Monster 1200 MY 2014-2021
 Monster 1200 S MY 2014-2021
 Monster 797 MY 2017-2021

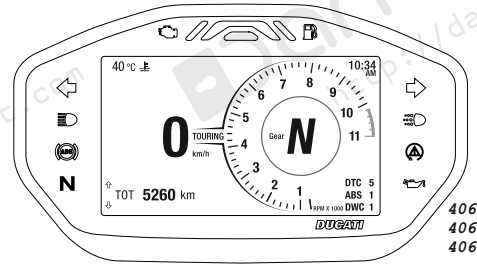

40611042L
 40611335C
 40611504A

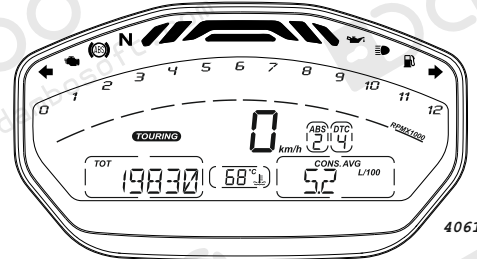

40611584A

Immobilizer System:

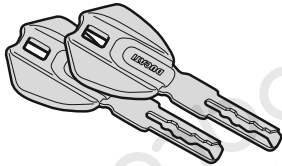

- Ducati I2K-2 Immobilizer system.
 - All vehicles equipped with I2K-2 Immobilizer system have a standard supply consisting in 2 keys.
 - The Keys are provided with a passive transponder Texas DST-80.
 - The key electronic codes are stored in the instrument panel control unit that work as Immobilizer.
- The number of keys that can be memorized by the I2K-2 system is 2 and it is not possible to program one or more than 2 keys.

Software options:

- * Immobilizer Keys programming
- * Show PIN code
- * VIN code edit
- * Odometr correction

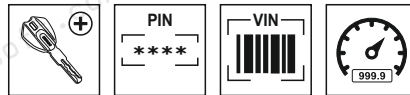

WARNING



The Immobilizer release function via Pin Code is available **ONLY** if the Customer has performed the memorization procedure of the secret code.

Spare tools/units:

- * Key Copy Tool - Copy Texas Crypto DST transponders
- * Key Production - Ducati Scrambler transponder generation



Description:

Module.....Dashboard
 Ref OEM.....40611111G
 Memory device.....Eeprom 24C512
 Memory size.....65536 bytes
 Vehicles.....Scrambler MY 2015-2020:
 Scrambler Icon
 Scrambler Full Throttle
 Scrambler Classic
 Scrambler Urban Enduro
 Scrambler Italia Independent
 Scrambler Cafè Racer
 Scrambler Flat Track Pro
 Scrambler Desert Sled
 Scrambler Mach 2.0



Immobilizer System:

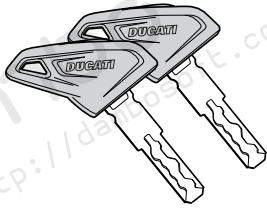

- Ducati I2K-2 Immobilizer system.
- All vehicles equipped with I2K-2 Immobilizer system have a standard supply consisting in 2 keys.
- The Keys are provided with a passive transponder Texas DST-80.
- The key electronic codes are stored in the instrument panel control unit that work as Immobilizer.
- The number of keys that can be memorized by the I2K-2 system is 2 and it is not possible to program one or more than 2 keys.

Software options:

- * Immobilizer Keys programming
- * Show PIN code
- * VIN code edit
- * Odometer correction

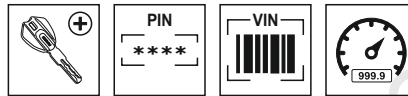

Spare tools/units:

- * [Key Copy Tool](#) - Copy Texas Crypto DST transponders
- * [Key Production](#) - Ducati Scrambler transponder generation



Description:

Module.....Dashboard
 Ref OEM.....40611532B
 Memory device.....Eeprom 95C512
 Memory size.....65536 bytes
 Vehicles.....Scrambler 1100 MY 2018-2022:
 Scrambler 1100
 Scrambler 1100 Sport
 Scrambler 1100 Special
 Scrambler 1100 Pro
 Scrambler 1100 Sport Pro
 Scrambler 1100 Dark Pro

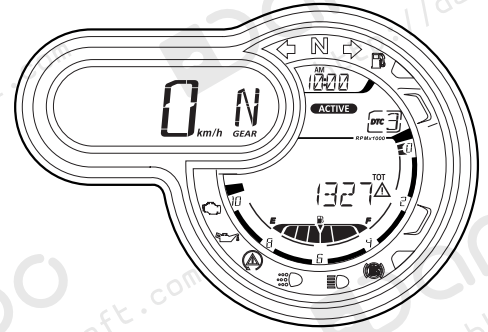

Immobilizer System:

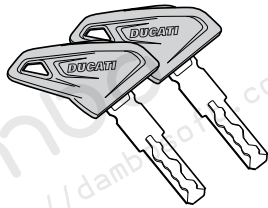

- Ducati I2K-2 Immobilizer system.
- All vehicles equipped with I2K-2 Immobilizer system have a standard supply consisting in 2 keys.
- The Keys are provided with a passive transponder Texas DST-80.
- The key electronic codes are stored in the instrument panel control unit that work as Immobilizer.
- The number of keys that can be memorized by the I2K-2 system is 2 and it is not possible to program one or more than 2 keys.

Software options:

- * Immobilizer Keys programming
- * Show PIN code
- * VIN code edit
- * Odometr correction

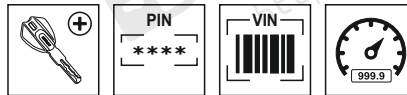

Spare tools/units:

- * Dump Tools/Unit DT0020 - Ducati Black Box control unit
- * Key Copy Tool - Copy Texas Crypto DST transponders
- * Key Production - Ducati transponder generation



Description:



Module.....Dashboard
 Manufacturer.....M.A.E. elettronica
 Ref OEM.....40611261B
 Memory device.....9S12G192 Freescale MCU (QFP100)
 Memory type.....MCU Eeprom
 Memory size.....4096 bytes
 Vehicles.....Ducati Multistrada 950 MY 2017-2020

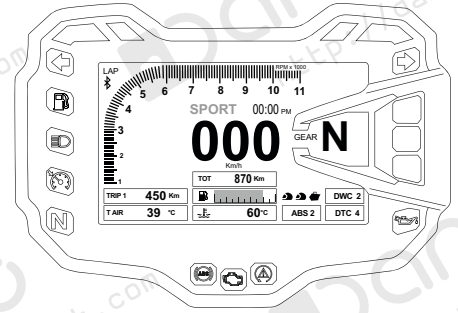

Immobilizer System:

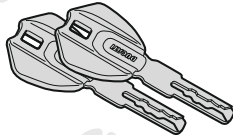

- Ducati I2K-2 Immobilizer system.
- All vehicles equipped with I2K-2 Immobilizer system have a standard supply consisting in 2 keys.
- The Keys are provided with a passive transponder Texas DST-80.
- The key electronic codes are stored in the instrument panel control unit that work as Immobilizer.
- The number of keys that can be memorized by the I2K-2 system is 2 and it is not possible to program one or more than 2 keys.

Software options:

- * Immobilizer Keys programming
- * Show PIN code
- * VIN code edit
- * Odometr correction

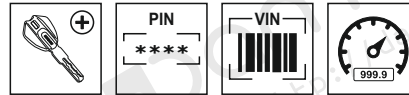

NOTE

* This unit for Ducati Multistrada 950 with passive keys (without hands free unit).
 Ducati Multistrada 1200 (MY 2015+) with hands free module equipped same dashboard without Immobilizer system. For this models use:

- [Dump Tools/Unit Dt0021](#) (HF Immobilizer unit) for Key programming
- [Dump Tools/Unit Dt0022](#) (Dashboard) for odometr/vin correction

Spare tools/units:

- * [Dump Tools/Unit DT0020](#) - Ducati Black Box control unit
- * [Key Copy Tool](#) - Copy Texas Crypto DST transponders
- * [Key Production](#) - Ducati Multistrada transponder generation



Description:



Module.....Dashboard
 Manufacturer.....MTA
 Ref OEM.....40611055G
 40611301B
 40611491A

Memory device.....Eeprom 24C16
 Memory size.....2048 bytes

Vehicles.....Ducati Monster 821 MY 2015-2017

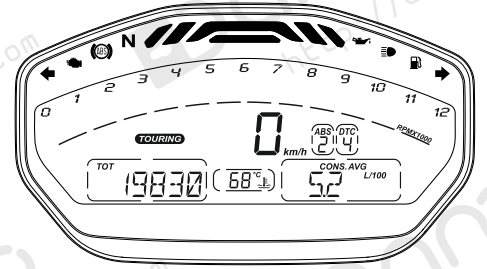

Immobilizer System:

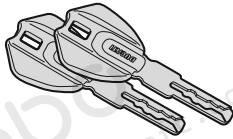

- Ducati I2K-2 Immobilizer system.
- All vehicles equipped with I2K-2 Immobilizer system have a standard supply consisting in 2 keys.
- The Keys are provided with a passive transponder Texas DST-80.
- The key electronic codes are stored in the instrument panel control unit that work as Immobilizer.
- The number of keys that can be memorized by the I2K-2 system is 2 and it is not possible to program one or more than 2 keys.

Software options:

- * Immobilizer Keys programming
- * Show PIN code
- * VIN code edit
- * Odometr correction

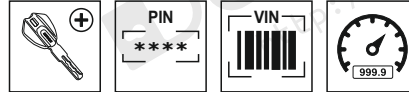

Spare tools/units:

- * [Dump Tools/Unit DT0020](#) - Ducati Black Box control unit
- * [Key Copy Tool](#) - Copy Texas Crypto DST transponders
- * [Key Production](#) - Ducati transponder generation



Description:

Module.....Ducati BlackBox control unit
 Ref OEM.....38510191C
 38512041B
 38510905A
 Memory device.....Eeprom 24C16
 Memory size.....2048 bytes

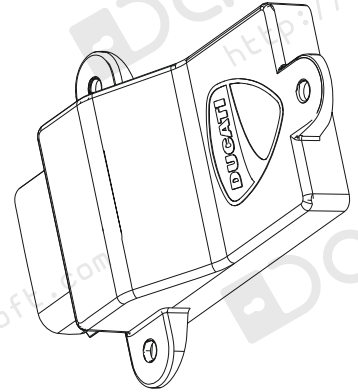

Software options:

- * VIN code edit
- * Odometr correction



Spare tools/units:

- * [Dump Tools/Unit Dt0017](#) - Ducati Scrambler 1100 Dashboard
- * [Dump Tools/Unit Dt0019](#) - Ducati Monster 821 Dashboard
- * [Dump Tools/Unit Dt0022](#) - Ducati Multistrada 1200 Dashboard
- * [Dump Tools/Unit Dt0023](#) - Ducati Multistrada 1200 Dashboard



Description:

Module.....Hands-Free control unit
 Manufacturer.....ZADI
 Ref OEM.....38510761B
 38510742B

Memory device.....Eeprom 24C04
 Memory size.....512 bytes

Vehicles.....Ducati Diavel
 Ducati XDiavel
 Ducati Multistrada 1200

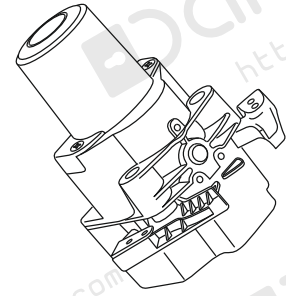

Immobilizer System:

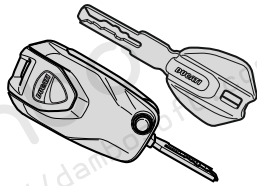

- Ducati HF Immobilizer system.
- All vehicles equipped with HF Immobilizer system have a standard supply consisting in:
 - 1 active key
 - 1 passive key

Software options:

* Immobilizer Keys programming



Spare tools/units:

- * Dump Tools/Unit DT0020 - Ducati Black Box ECU unit
- * Dump Tools/Unit Dt0022 - Ducati Dashboard
- * Dump Tools/Unit Dt0023 - Ducati Dashboard



Description:

Module.....Dashboard
 Manufacturer.....M.A.E. elettronica
 Memory device.....9S12G192 Freescale MCU (QFP100)
 Memory type.....MCU Eeprom
 Memory size.....4096 bytes
 Vehicles.....Ducati Multistrada 1200 MY 2015

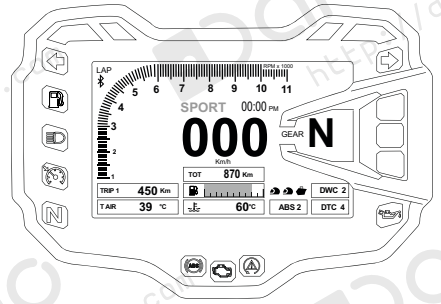

Software options:

- * VIN code edit
- * Odometer correction



Spare tools/units:

- * Dump Tools/Unit DT0020 - Ducati Black Box control unit
- * Dump Tools/Unit Dt0021 - Ducati Hands Free Immobilizer unit
- *



Description:

Module.....Dashboard
 Ref OEM.....40610871B
 40610872B
 40610873B
 Vehicles.....Multistrada MY 2010-2014:
 Multistrada 1200
 Multistrada 1200S
 Multistrada 1200S Sport
 Multistrada 1200S Touring
 Multistrada 1200S Pikes Peak
 Memory device.....Eeprom 24C16
 Memory size.....2048 bytes

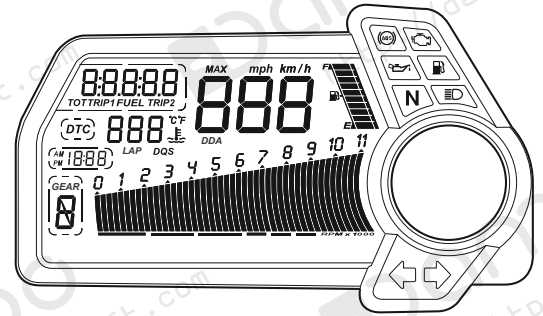

Software options:

- * Show PIN code
- * VIN code edit
- * Odometr correction



Spare tools/units:

- * Dump Tools/Unit DT0020 - Ducati BlackBox control unit
- * Dump Tools/Unit Dt0021 - Ducati Hands Free Immobilizer unit